

# OCENME

## OSP12N65C / OSF12N65C

### 650V N-Channel MOSFET

#### General Description

This Power MOSFET is produced using ocenme's advanced planar stripe DMOS technology. This advanced technology has been especially tailored to minimize on-state resistance, provide superior switching performance, and withstand high energy pulse in the avalanche and commutation mode. These devices are well suited for high efficiency switched mode power supplies, active power factor correction based on half bridge topology.

#### Features

- 12.0A, 650V,  $R_{DS(on)} = 0.750\Omega @ V_{GS} = 10\text{ V}$
- Low gate charge ( typical 52nC)
- High ruggedness
- Fast switching
- 100% avalanche tested
- Improved dv/dt capability

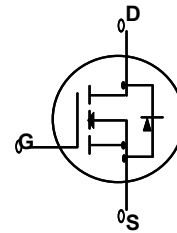
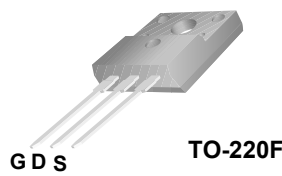
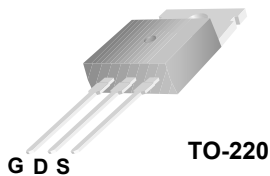

#### Absolute Maximum Ratings $T_C = 25^\circ\text{C}$ unless otherwise noted

Symbol	Parameter	OSP12N65C	OSF12N65C	Units
$V_{DSS}$	Drain-Source Voltage	650		V
$I_D$	Drain Current - Continuous ( $T_C = 25^\circ\text{C}$ ) - Continuous ( $T_C = 100^\circ\text{C}$ )	12.0	12.0 *	A
		7.4	7.4 *	A
$I_{DM}$	Drain Current - Pulsed (Note 1)	48	48 *	A
$V_{GSS}$	Gate-Source Voltage	$\pm 30$		V
$E_{AS}$	Single Pulsed Avalanche Energy (Note 2)	865		mJ
$E_{AR}$	Repetitive Avalanche Energy (Note 1)	23.1		mJ
dv/dt	Peak Diode Recovery dv/dt (Note 3)	4.5		V/ns
$P_D$	Power Dissipation ( $T_C = 25^\circ\text{C}$ ) - Derate above $25^\circ\text{C}$	231	54	W
		1.85	0.43	W/ $^\circ\text{C}$
$T_J, T_{STG}$	Operating and Storage Temperature Range	-55 to +150		$^\circ\text{C}$
$T_L$	Maximum lead temperature for soldering purposes, 1/8" from case for 5 seconds	300		$^\circ\text{C}$

\* Drain current limited by maximum junction temperature.

#### Thermal Characteristics

Symbol	Parameter	OSP12N65C	OSF12N65C	Units
$R_{\theta JC}$	Thermal Resistance, Junction-to-Case	0.54	2.33	$^\circ\text{C}/\text{W}$
$R_{\theta CS}$	Thermal Resistance, Case-to-Sink Typ.	0.5	--	$^\circ\text{C}/\text{W}$
$R_{\theta JA}$	Thermal Resistance, Junction-to-Ambient	62.5	62.5	$^\circ\text{C}/\text{W}$

# OSP12N65C / OSF12N65C

## Electrical Characteristics

$T_C = 25^\circ\text{C}$  unless otherwise noted

Symbol	Parameter	Test Conditions	Min	Typ	Max	Units
<b>Off Characteristics</b>						
$BV_{DSS}$	Drain-Source Breakdown Voltage	$V_{GS} = 0\text{ V}, I_D = 250\ \mu\text{A}$	650	--	--	V
$\frac{\Delta BV_{DSS}}{\Delta T_J}$	Breakdown Voltage Temperature Coefficient	$I_D = 250\ \mu\text{A}$ , Referenced to $25^\circ\text{C}$	--	0.7	--	$^\circ\text{C}^{-1}$
$I_{DSS}$	Zero Gate Voltage Drain Current	$V_{DS} = 650\text{ V}, V_{GS} = 0\text{ V}$	--	--	1	$\mu\text{A}$
		$V_{DS} = 520\text{ V}, T_C = 125^\circ\text{C}$	--	--	10	$\mu\text{A}$
$I_{GSSF}$	Gate-Body Leakage Current, Forward	$V_{GS} = 30\text{ V}, V_{DS} = 0\text{ V}$	--	--	100	nA
$I_{GSSR}$	Gate-Body Leakage Current, Reverse	$V_{GS} = -30\text{ V}, V_{DS} = 0\text{ V}$	--	--	-100	nA

## On Characteristics

$V_{GS(th)}$	Gate Threshold Voltage	$V_{DS} = V_{GS}, I_D = 250\ \mu\text{A}$	2.0	--	4.5	V
$R_{DS(on)}$	Static Drain-Source On-Resistance	$V_{GS} = 10\text{ V}, I_D = 6.0\text{ A}$	--	0.63	0.75	$\Omega$

## Dynamic Characteristics

$C_{iss}$	Input Capacitance	$V_{DS} = 25\text{ V}, V_{GS} = 0\text{ V},$ $f = 1.0\text{ MHz}$	--	1850	--	pF
$C_{oss}$	Output Capacitance		--	180	--	pF
$C_{rss}$	Reverse Transfer Capacitance		--	20	--	pF

## Switching Characteristics

$t_{d(on)}$	Turn-On Delay Time	$V_{DD} = 325\text{ V}, I_D = 12.0\text{ A},$ $R_G = 25\ \Omega$	--	30	--	ns	
$t_r$	Turn-On Rise Time		--	90	--	ns	
$t_{d(off)}$	Turn-Off Delay Time		(Note 4, 5)	--	140	--	ns
$t_f$	Turn-Off Fall Time		(Note 4, 5)	--	90	--	ns
$Q_g$	Total Gate Charge		$V_{DS} = 520\text{ V}, I_D = 12.0\text{ A},$ $V_{GS} = 10\text{ V}$	--	52	--	nC
$Q_{gs}$	Gate-Source Charge	(Note 4, 5)	--	8.5	--	nC	
$Q_{gd}$	Gate-Drain Charge		--	20.0	--	nC	

## Drain-Source Diode Characteristics and Maximum Ratings

$I_S$	Maximum Continuous Drain-Source Diode Forward Current	--	--	12	A	
$I_{SM}$	Maximum Pulsed Drain-Source Diode Forward Current	--	--	48	A	
$V_{SD}$	Drain-Source Diode Forward Voltage	$V_{GS} = 0\text{ V}, I_S = 12.0\text{ A}$	--	--	1.4	V
$t_{rr}$	Reverse Recovery Time	$V_{GS} = 0\text{ V}, I_S = 12.0\text{ A},$ $di_F / dt = 100\text{ A}/\mu\text{s}$	--	430	--	ns
$Q_{rr}$	Reverse Recovery Charge	(Note 4)	--	5.0	--	$\mu\text{C}$

### Notes:

1. Repetitive Rating : Pulse width limited by maximum junction temperature
2.  $L = 11\text{ mH}, I_{AS} = 12.0\text{ A}, V_{DD} = 50\text{ V}, R_G = 25\ \Omega$ , Starting  $T_J = 25^\circ\text{C}$
3.  $I_{SD} \leq 12.0\text{ A}, di/dt \leq 200\text{ A}/\mu\text{s}, V_{DD} \leq BV_{DSS}$ , Starting  $T_J = 25^\circ\text{C}$
4. Pulse Test : Pulse width  $\leq 300\ \mu\text{s}$ , Duty cycle  $\leq 2\%$
5. Essentially independent of operating temperature

# OSP12N65C / OSF12N65C

## Typical Characteristics

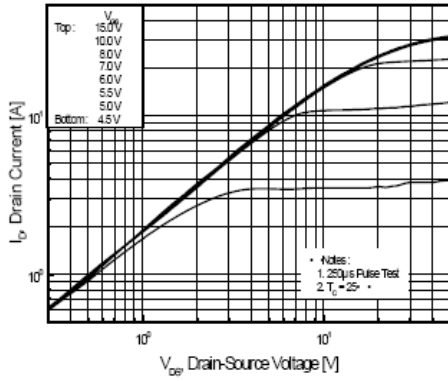

Figure 1. On-Region Characteristics

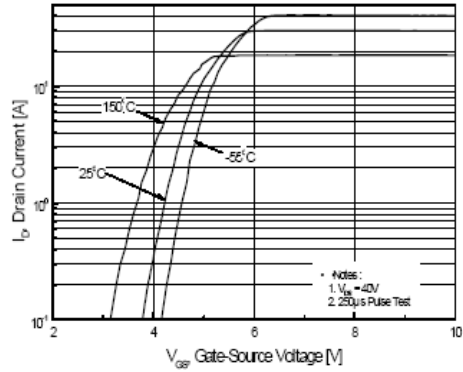

Figure 2. Transfer Characteristics

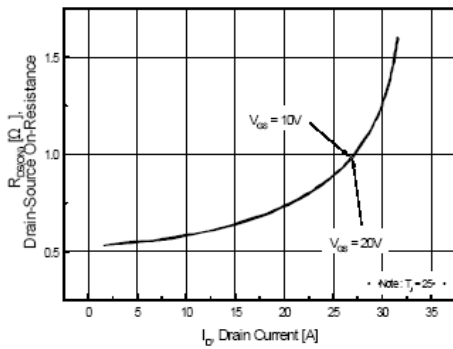

Figure 3. On-Resistance Variation vs Drain Current and Gate Voltage

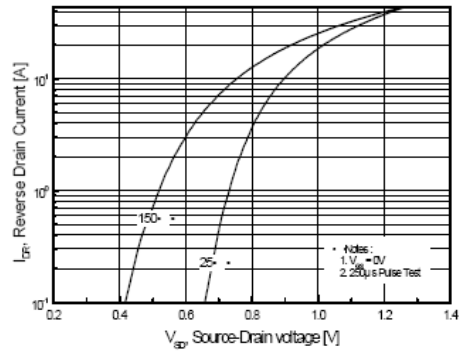

Figure 4. Body Diode Forward Voltage Variation with Source Current and Temperature

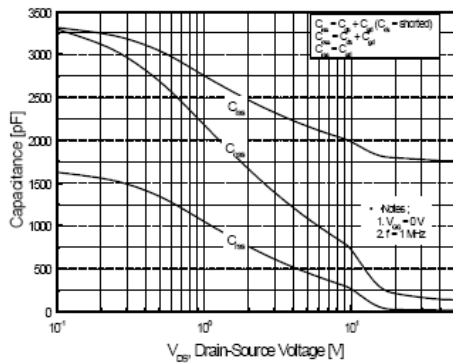

Figure 5. Capacitance Characteristics

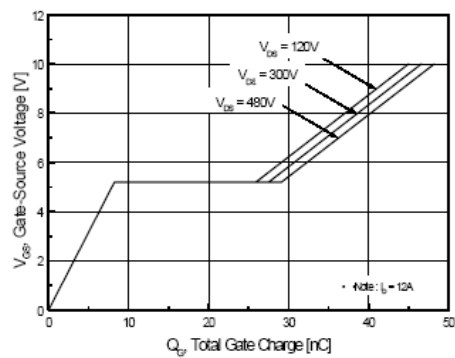
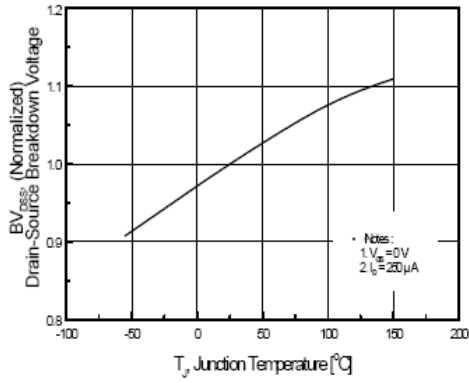

Figure 6. Gate Charge Characteristics

# OSP12N65C / OSF12N65C

## Typical Characteristics (Continued)



**Figure 7. Breakdown Voltage Variation vs Temperature**

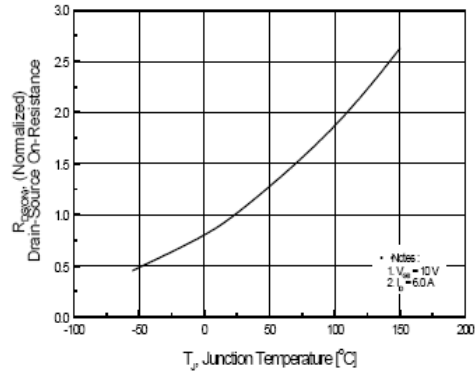

**Figure 8. On-Resistance Variation vs Temperature**

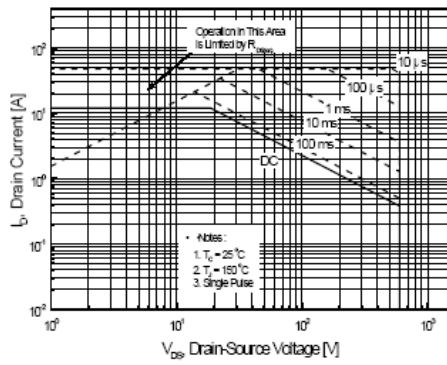

**Figure 9-1. Maximum Safe Operating Area for OSP12N65C**

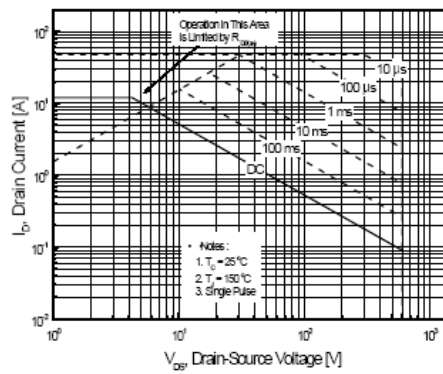

**Figure 9-2. Maximum Safe Operating Area for OSF12N65C**

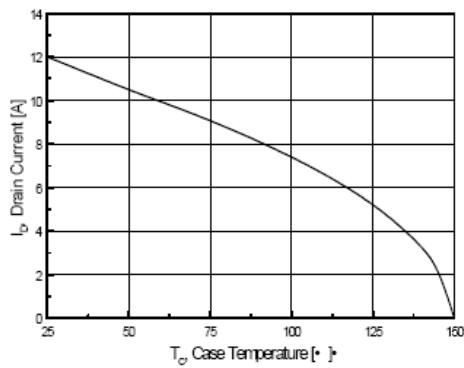

**Figure 10. Maximum Drain Current vs Case Temperature**

# OSP12N65C / OSF12N65C

## Typical Characteristics (Continued)

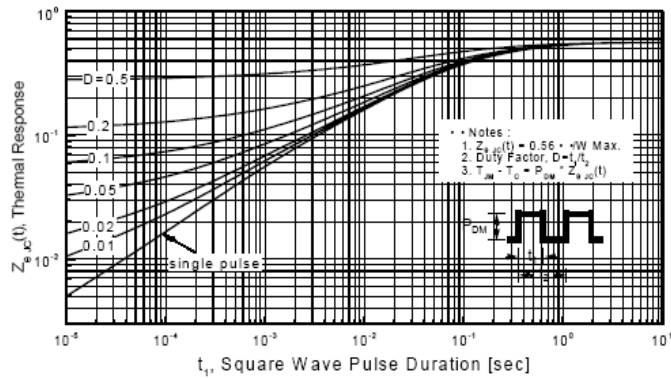

Figure 11-1. Transient Thermal Response Curve for OSP12N65C

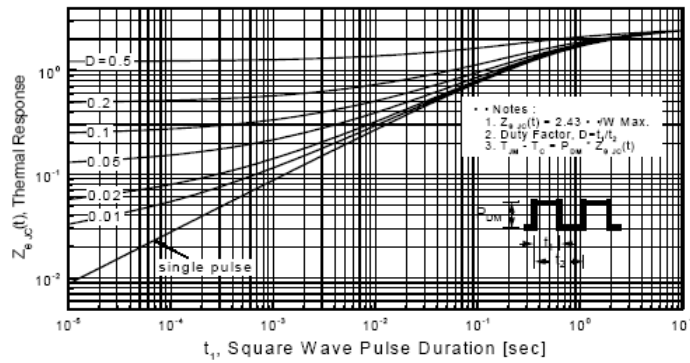
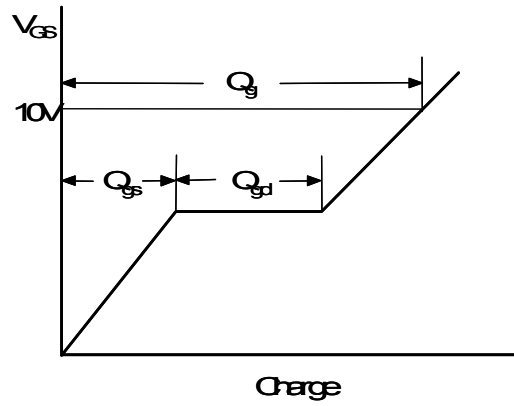
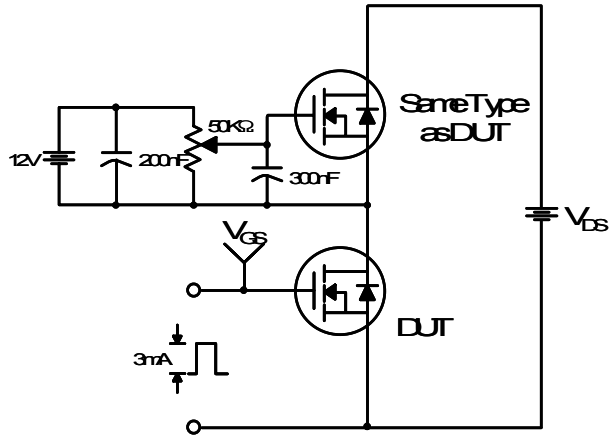

Figure 11-2. Transient Thermal Response Curve for OSF12N65C

# OSP12N65C / OSF12N65C

Gate Charge Test Circuit & Waveform



Resistive Switching Test Circuit & Waveforms

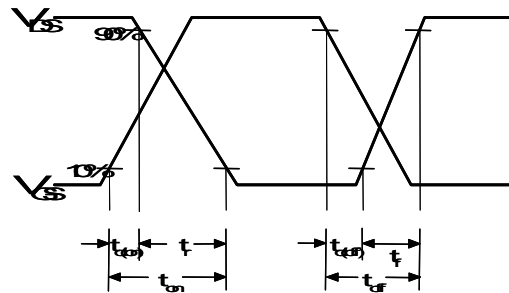
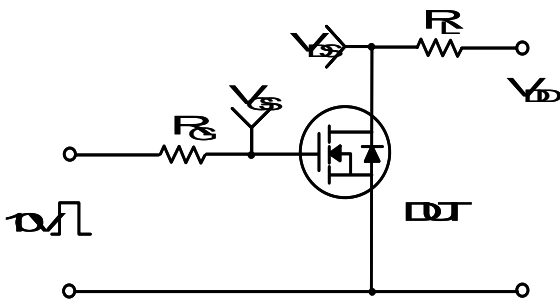

Unclamped Inductive Switching Test Circuit & Waveforms

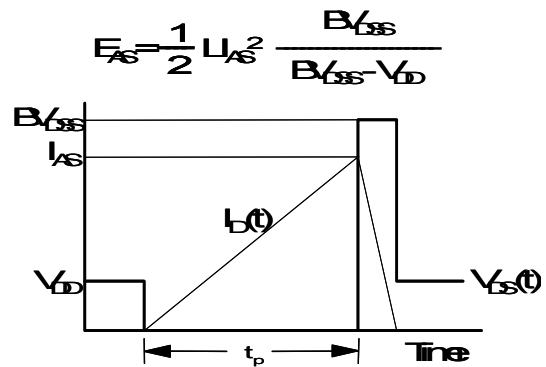
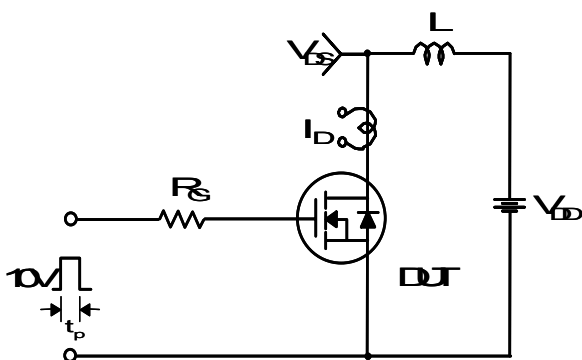

# OSP12N65C / OSF12N65C

Peak Diode Recovery dv/dt Test Circuit & Waveforms

